

# 新北市 107 學年度學生能力檢測五年級英語試題卷 (聽讀測驗)

(請在答案卡上作答)

學校：\_\_\_\_\_ 五年\_\_\_\_\_班 座號：\_\_\_\_\_ 姓名：\_\_\_\_\_

## A. 聽力測驗

一、請仔細聽，選出聽到的字母。

( 2 ) 例： ① L ② H ③ F ④ A

( 1 ) 1. ① x ② p ③ s ④ q

( 1 ) 2. ① Q ② O ③ U ④ W

( 2 ) 3. ① e ② a ③ c ④ o

( 4 ) 4. ① T ② D ③ P ④ B

( 3 ) 5. ① j ② g ③ y ④ i

Script: 例: H 1. x 2. Q 3. a 4. B 5. y

二、請仔細聽單字，選出空格中應該填入的字母。

( 1 ) 例： \_\_ook ① b ② c ③ h ④ l

( 1 ) 6. \_\_ate ① g ② h ③ l ④ f

( 4 ) 7. \_\_est ① b ② t ③ w ④ v











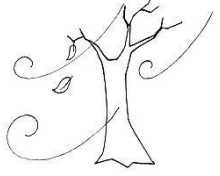
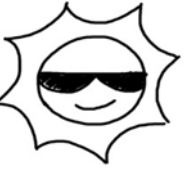
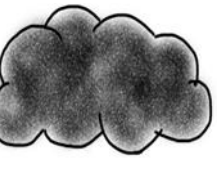

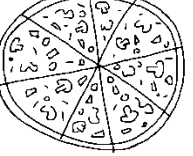
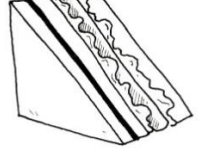

( 3 ) 8. \_\_ug ① h ② b ③ m ④ r

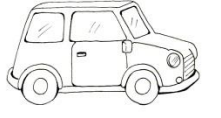
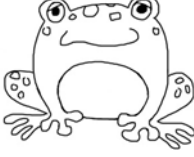



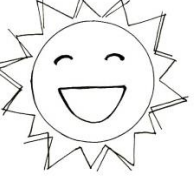



( 2 ) 9. b\_\_g ① a ② i ③ e ④ u

( 3 ) 10. t\_\_b ① i ② o ③ u ④ a

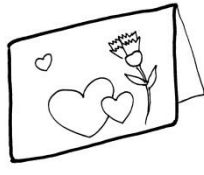
Script: 例: book 6. gate 7. vest 8. mug 9. big 10. tub





三、請仔細聽單字，選出正確的圖片。



例：( 3 )	① 	② 	③ 	④ 
11. ( 2 )	① 	② 	③ 	④ 
12. ( 1 )	① 	② 	③ 	④ 
13. ( 3 )	① 	② 	③ 	④ 
14. ( 4 )	① 	② 	③ 	④ 







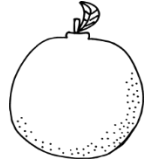
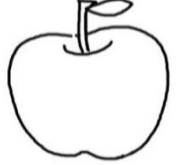

15. ( 4 )	① 	② 	③ 	④ 
16. ( 1 )	① 	② 	③ 	④ 

Script: 例: sunny 11. hamburger 12. bus 13. rabbit 14. cold 15. star 16. rice dumpling

四、請仔細聽老師所唸的單字，先選出正確的圖片，再於下一題選出對應的單字。

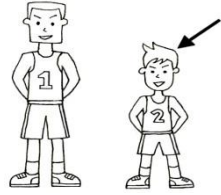
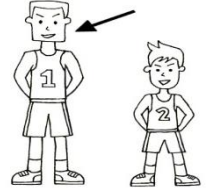
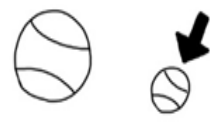
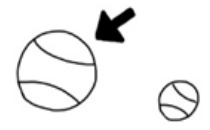
例：( 3 )	題組題	① 	② 	③ 	④ 
例：( 1 )		① book	② ruler	③ marker	④ chair

17. ( 3 )	題組 A	① 	② 	③ 	④ 
18. ( 2 )		① cake	② banana	③ orange	④ apple

19. ( 1 )	題組 B	① 	② 	③ 	④ 
20. ( 4 )		① six	② five	③ ten	④ three
21. ( 3 )	題組 C	① 	② 	③ 	④ 
22. ( 4 )		① short	② tall	③ big	④ small
23. ( 1 )	題組 D	① 	② 	③ 	④ 
24. ( 2 )		① write	② dance	③ draw	④ read

Script: 例: book 17、18. banana 19、20. three 21、22. small 23、24. dance

五、請仔細聽句子或對話，選出正確的圖片。

例：(4)	①	②	③	④
25. (2)	①	②	③	④
26. (1)	①	②	③	④
27. (3)	①	②	③	④
28. (4)	①	②	③	④

29. (3)	①	②	③	④
30. (1)	①	②	③	④
31. (2)	①	②	③	④
32. (4)	①	②	③	④

五. Script:

例: I'm nine years old.

25. He's my father.

26. It's twelve o'clock.

27. I like cats.

28. The dog can swim.

29. Come here.

30. Put down your hand.

31. A: I'm done. B: Good job.

32. A: Listen!

B: Cool! The bird is singing.

六、請仔細聽問句，選出最適當的答句。

例：( 1 )	① No, it isn't. ② It's hot. ③ Yes, I am. ④ He's not Tom.
33. ( 2 )	① You want a car. ② I want a car. ③ It's a car. ④ I am a student.
34. ( 3 )	① It's nine. ② It's in the living room. ③ It's blue. ④ It's a monkey.
35. ( 4 )	① My father is a teacher. ② This is my pen. ③ Your name is Amy. ④ My name is David.
36. ( 1 )	① It's sunny. ② It's a sun. ③ I'm happy. ④ She's cold.

37. ( 2 )	① She can dance. ② She's my sister. ③ She is hungry. ④ She's ten.
-----------	--

六. Script:

例: Is this a robot?

33. What do you want?

34. What color is it?

35. What's your name?

36. How's the weather?

37. Who's she?

### B. 閱讀測驗

七、請仔細看圖片，選出最適當的單字。

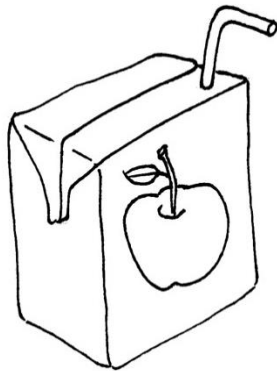
例：( 1 )		① eat ② like ③ read ④ want
38. ( 3 )		① tea ② water ③ juice ④ milk

39. ( 3 )

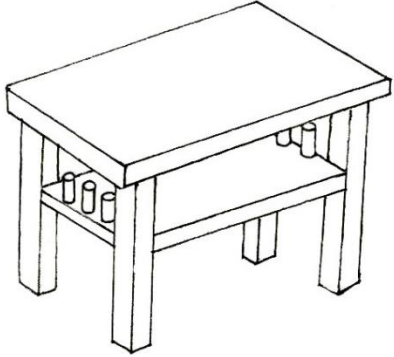

① book  
② box  
③ desk  
④ school

40. ( 2 )



① read  
② sing  
③ draw  
④ write

41. ( 1 )



① teacher  
② doctor  
③ grandfather  
④ student

42. ( 4 )



① good  
② happy  
③ angry  
④ sad

43. ( 4 )

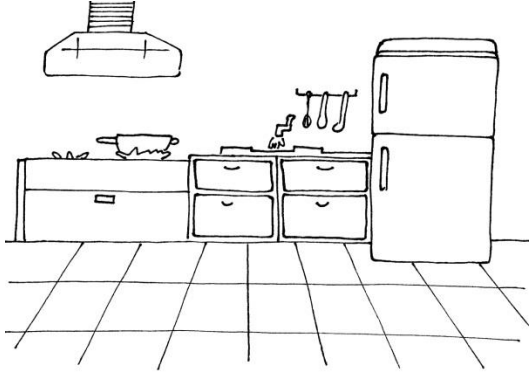

① bedroom  
② living room  
③ bathroom  
④ kitchen

44. ( 1 )



① Christmas tree  
② flower  
③ vampire  
④ Santa Claus

45. ( 2 )



① card  
② dragon boat  
③ candy cane  
④ rice dumpling

八、請仔細看圖片，選出最符合圖意的句子。

例：( 1 )

① I'm happy.  
 ② I'm sad.  
 ③ I'm angry.  
 ④ I'm tired.



46. ( 4 )

① She is Mary.  
 ② She likes hot dogs.  
 ③ She is nine.  
 ④ She likes ice cream.



47. ( 2 )

① The turtle is on the box.  
 ② The rabbit is in the box.  
 ③ The frog is on the box.  
 ④ The turtle is in the box.

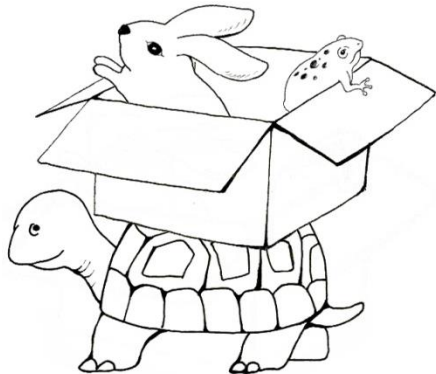

48. ( 3 )

① My grandma is sleeping in the kitchen.  
 ② My sister is reading in the living room.  
 ③ My brother is singing in the living room.  
 ④ My grandpa is writing in the kitchen.



九、請仔細讀下面的問句或短文，選出最適當的答案。

Where are you?

例：( 4 )

① I'm happy.  
 ② I'm fine.  
 ③ I'm a student.  
 ④ I'm in the living room.

What's your name?

49. ( 1 )

① I'm John.  
 ② He's Tom.  
 ③ She's Amy.  
 ④ You are Candy.

50. ( 4 )	Do you like rice?
	① No, you don't. ② No, she doesn't. ③ Yes, he does. ④ No, I don't.
51. ( 2 )	Are you hungry?
	① Yes, you are. ② Yes, I am. ③ No, I don't. ④ No, she isn't.
請閱讀短文 並回答下列 52~54 題。	Tom: Hi, John. Where are you? John: I'm at school. Tom: Why? It's five o'clock. John: I'm singing. Do you want to come sing with me? Tom: Sure! I like to sing.  <p style="text-align: right;">*sing with me 和我一起唱</p>

52. ( 4 )	Where is John?
	① He's in the bathroom. ② He's in the kitchen. ③ He's at home. ④ He's at school.
53. ( 3 )	What is John doing?
	① He is swimming. ② He is dancing. ③ He is singing. ④ He is reading.
54. ( 1 )	Can Tom come to sing?
	① Yes, he can. ② Yes, he is. ③ No, he can't. ④ No, he isn't.